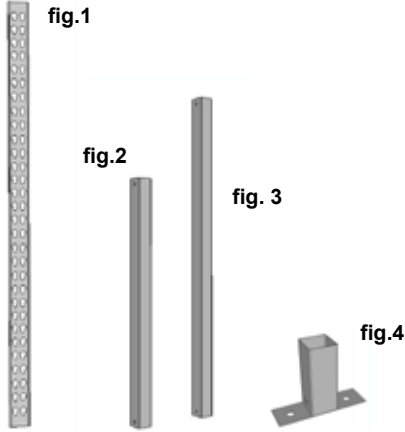


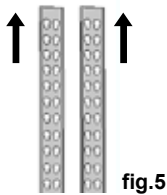
FastRak Assembly Instructions



STEP 1 - Ensure all pieces are present:

- 3'H Set:** 4 Upright Posts (fig. 1)
4 Horizontal Supports (fig. 2)
2 Diagonal Supports (fig.3)
- 6'H ~ 8'H Set:** 4 Upright Posts (fig. 1)
6 Horizontal Supports (fig. 2)
4 Diagonal Supports (fig.3)
- 10'H ~ 12'H Set:** 4 Upright Posts (fig. 1)
8 Horizontal Supports (fig. 2)
6 Diagonal Supports (fig.3)

***Optional Foot Plates:** 1 per upright post (fig. 4)



STEP 2 - Position Upright Posts:

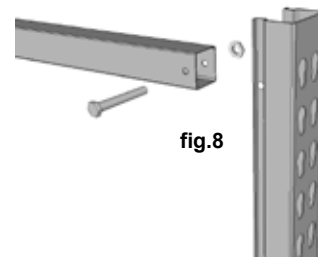
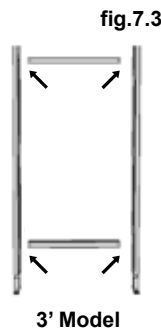
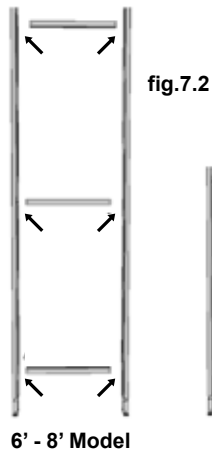
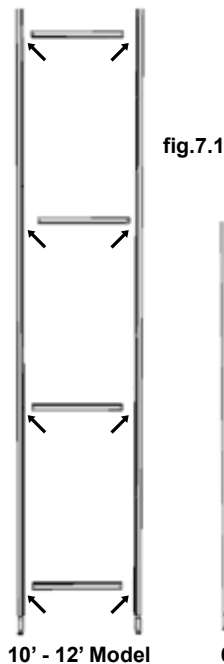
Place two upright posts on the floor and ensure both uprights are coordinated with teardrops in the same direction (fig. 5)

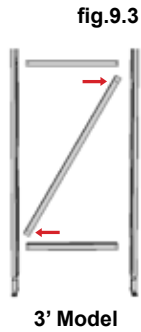
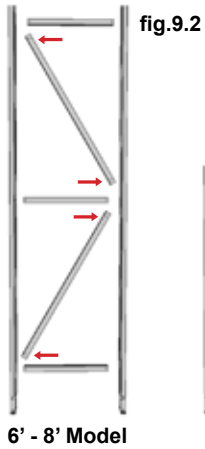
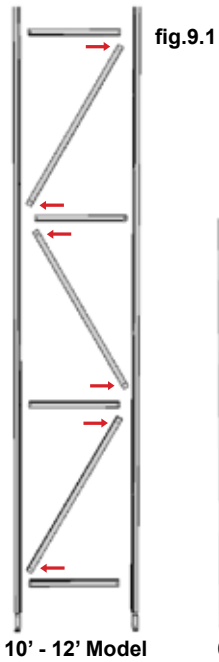


fig.6

STEP 3 - Install Horizontal Supports:

Horizontal supports are the shorter supports and can be identified by measurements that are stamped onto the bar in mm (fig. 6). Insert horizontal supports in the indicated spots as shown in Figures: 7.1, 7.2, and 7.3. Use a socket wrench to turn supplied bolts into the nuts while holding the nuts in place with a crescent wrench (fig. 8).

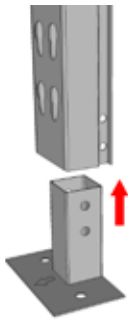




STEP 4 - Install Diagonal Supports:

Install diagonal supports in the appropriate locations indicated in Figures: 9.1, 9.2, and 9.3. Supports need to be installed in opposite directions as shown in the diagrams appropriate for your unit size.

fig.10



STEP 5 - Install Optional Foot Plates:

Foot plates are installed to the bottom of each upright post (fig. 10). Ensure the arrow stamped on the foot plate is facing outward from the upright as shown. Two screws and nuts fasten each foot plate to a post.



FastRak Upright is completed